

Packings

Technical Principles

Packings	754
Media Table	756
Media Register	758
Standardisation Proposals	762
Examples of use	764
Fitting Instructions	766

Products

Products	769
Design Types	770

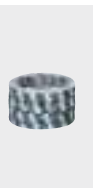

Packings

Simrit Packings for energy supply offer a great degree of flexibility for efficient applications and the security of the highest sealing function.

The combination of tried-and-trusted material qualities in conjunction with new material developments enables Simrit to be able to seal a broad range of application cases reliably with only a few different packing types. The limited stocking requirements for various packing types allows the customer to optimise costs effectively.

Requirements

- Efficiency for a wide application spectrum
- High seal reliability
- Long service life
- Reduction of the emission values
- Customer-specific solutions.



Features

Depending on type and application range, our packings offer:

- Low thermal expansion with excellent heat dissipation insulation
- Long service life
- Low friction
- High wear resistance and rot-resistance with soiled media
- Shaft-protecting natural fibres for longer service life
- High pressure resistance
- Easy fitting.

Application range

Merkel Packings are used in a large number of processes in energy supply due to their universal properties and simultaneous simple customer customisation.

- Pump seals in boiler feed water area
- Cooling water pumps
- Pumps in ancillary machines
- Spindle seals in valves
- Cover seals
- Soot blower seals up to 550°C operating temperature.

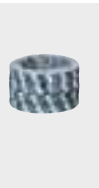

Media Table

Main media groups with reference numbers

Main media groups	Merkel Packings														
	Ramilon 4586	Arostat 6204	Arolan II 6215	Arochem S 6216	Unistat 6303	Unichem 6313	Unival 6323	Kombilon 6742	Alchem 6375	Grafflex 6501	Carbosteam 6550	G-Spezial 6560	G-Spezial S 6565	Univerdit 7000	Uniflex 6588
1 Alkalis															
1.1 Diluted alkalis	●	●	●	●	●	●	●	●	●	●	●	●	●	●	●
1.2 Concentrated alkalis		●			●	●	●	●	●	●	●	●	●	●	●
2 Steam															
2.1 ... 180 °C		●		●	●		●	●	●	●	●	●	●	●	●
2.2 ... 280 °C				●	●				●	●	●	●	●		●
2.3 ... 550 °C										●	●	●	●		
3 Vapours and gases															
3.1 Inert gases, air	●	●	●	●	●	●	●	●	●	●	●	●	●	●	●
3.2 Volatile hydro-carbons solvent vapours		●	●	●	●	●	●	●	●	●	●	●	●	●	●
3.3 Acidic gases			●		●	●	●	●	●	●		●	●	●	●
3.4 Oxygen					●					●					●
Hydrogen		●	●	●	●		●	●	●	●				●	●
4 Solvents															
(Aliphatic and aromatic hydro-carbons, aldehyde, alcohols, esters, ketones, chlorinated hydro-carbons)	●	●	●	●	●	●	●	●	●	●	●	●	●	●	●
5 Oils and greases															
5.1 Mineral oils and greases, plant and animal oils and greases	●	●	●	●	●	●	●	●	●	●	●	●	●	●	●
5.2 Synthetic oils, heat transfer oils		●	●	●	●		●	●	●	●		●	●		●

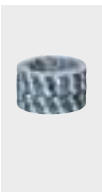

Main media groups	Merkel Packings														
	Ramilon 4586	Arostat 6204	Arolan II 6215	Arochem S 6216	Unistat 6303	Unichem 6313	Unival 6323	Kombilon 6742	Alchem 6375	Grafflex 6501	Carbosteam 6550	G-Spezial 6560	G-Spezial S 6565	Univerdit 7000	Uniflex 6588
6 Acids															
6.1 Strongly diluted organic and inorganic acids	●	●	●	●	●	●	●	●	●	●	●	●	●	●	●
6.2 Concentrated acids, inorganic acids of medium concentration	○	○	○	●	●	●	●	●	●	●	●	●	●	●	○
6.3 Concentrated inorganic acids				●	●	●	●	●	○	○	○				
7 Neutral aqueous solutions (salt solutions)	●	●	●	●	●	●	●	●	●	●	●	●	●	●	●
8 Other organic bonds (nitrile, amine, lactam)			●	●	●	●	●	●	●		●	●			●
9 Water															
9.1 Drinking water, sea water, waste water, hot water up to 100 °C	●	●	●	●	●	●	●	●	●	●	●	●	●	●	●
9.2 Hot water over 100 °C, boiler feed water	○	○	●	●	●	●	●	●	●	●	●	●	●	●	●

● suitable ○ of limited suitability

Tbl. 1 Media table

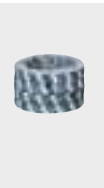

Media Register

Main media groups with reference numbers

A

Accumulator acid	6.2
Acetic acid	6.1; 6.2
Acetic acid, glacial	6.2
Acetic anhydride	6.2
Acetone	4
Acetylene	3.2
Acids of a sulphurous type	6.2; 6.3
Acrylonitrile	8
Adipic acid	6.1; 6.2
Aero-engine fuel (carburetor)	4
Alaum, aqueous	6.1
Aluminium acetate	7
Aluminium chloride	6.3
Aluminium sulphate	6.1
Ammonia, aqueous	1.1; 1.2
Ammonia, gaseous	1.2
Ammonia, liquid	1.2
Ammonium chloride	7
Ammonium sulphate	7
Aniline	8
Anti-freeze	4
Asphalt	4; 5.1
ASTM oils 1, 2, 3	5.1

B

Barium salts, aqueous	7
Benzaldehyde	4
Benzene	4
Benzene	4
Benzoic acid, aqueous	6.1; 6.2
Benzyl alcohol	4
Benzyl chloride	4
Bitumen	4; 5.1

Boiler feed water	9.1; 9.2
Borax, aqueous	7
Brake fluid (ATE blue)	5.2
Bromine	3.3
Butadiene	3.2; 4
Butane	3.2; 4
Butanediol	4
Butyl acetate	4
Butyl alcohol	4
Butylene glycol	4
Butyraldehyde	4
Butyric acid	6.1; 6.2

C

Calcium acetate	7
Calcium bisulphites	7; 6.1
Calcium chloride, aqueous	7
Calcium hydroxide, aqueous	1.1
Calcium hypochloride	6.1; 6.2
Camphor	8
Caprolactam	8
Carbon dioxide (gaseous)	3.1
Carbon disulphide	4
Carbon monoxide	3.1
Carbon tetrachloride	4
Caustic soda /sodium hydroxide	1.1; 1.2
Chlorinated paraffin	4
Chlorine water RT	6.2; 6.3
Chlorine, wet	3.3
Chloroacetic acid	6.2; 6.3
Chlorobenzene	4
Chloroform	4
Chlorosulfonic acid	6.1; 6.2
Chromic acid	6.2; 6.3

Citric acid 6.1; 6.2

Coconut oil 5.1

Cod liver oil 5.1

Coking-oven gas 3.1

Copper acetate, aqueous 7

Copper chloride, aqueous 7

Copper sulfite, aqueous 7

Cresylic acid 4

Crude oil 5.1; 4

Cyclohexane 4

Cyclohexanol 4

Cyclohexanone 4

D

Dibenzyl ether 4

Dibutyl ether 4

Dibutyl phtalate 4

Diesel oil 5.1

Diethanolamine 8

Diethyl ether 4

Diethyl sebacate 4

Diethylene glycol 4

Dimethylformamide 4

Dioctyl phtalate 4

Diphenyl oxide 4

Diphyl 5.2

Dowtherm A 5.2

E

Ethane 3.2

Ethanolamine 8

Ethyl acetate 4

Ethyl alcohol 4

Ethyl benzol 4

Ethyl chloride 4

Ethylene 3.2

Ethylene chloride 4

Ethylene dichloride 4

Ethylene glycol 4

Ethylene oxide 3.2

F

Faecal matter 9.1

Fatty acids 6.1; 6.2

Fatty alcohol 4

Ferric sulphate, aqueous 7

Fixing bath 1.1

Fluorine, dry 3.3

Fluorobenzene 4

Fluorosilicic acid 6.2; 6.3

Formaldehyde 4; 1.1

Formic acid 6.1; 6.2

Freon types 4

Frigen types 4

Furnace gas 3.2

Furnace gases, dry 3.2; 3.3

G

Gas oil 5.1

Gelatine 7

Glue, aqueous 7

Glycerine 4

Glycol 4

Greases 5.1

H

Heat transfer oil 5.2

Heating oil 5.1

Heptane 4

Hexane 4

Hydraulic fluids in accordance with DIN 51524 Group H, HL, H-LP

Hydraulic fluids/mineral oil based 5.1

Hydraulic fluids/phosphate ester based 5.2

Hydrazine 1.1; 1.2

Hydrobromic acid 6.1; 6.2

Hydrochloric acid 6.2; 6.3

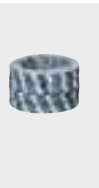

Hydrocyanic acid 6.1; 6.2

Hydrofluoric acid, concentrated 6.2

Hydrogen chloride gas 3.3

Hydrogen peroxide 7

I

Iodine tincture 4

Iodine-potassium iodide, aqueous 7

Iron nitrate 6.1

Iron-III-Chloride, aqueous 7

Isobutyl alcohol 4

Isobutyl ketone 4

Isooctane 4

Isopropanol 4

Isopropyl acetate 4

Isopropyl ether 4

L

Lactic acid 6.1

Lauryl alcohol 4

Lead acetate, aqueous 7

Lead salts, aqueous 7

Lithium chloride 7

M

Magnesium chloride 7

Magnesium hydroxide 1.1; 1.2

Magnesium sulphate 7

Maleic acid 6.1; 6.2

Maleic acid anhydride 6.2

Methacrylic acid methyl ester 4

Methane 3.2

Methanol 4

Methyl chloride 4

Methyl ethyl ketone (MEK) 4

Methyl glycol acetate 4

Methyl isobutyl ketone 4

Milk of lime 1.1; 1.2

Mineral oil 5.1

Monobromobenzene 4

Monochloroacetic acid 6.2; 6.3

N

Naphta 4

Naphthalene 4

Natural gas 3.2

Nickel sulphate 7

Nitric acid 6.2; 6.3

Nitrobenzene 4

O

Oleum 6.3

Oxalic acid 6.1; 6.2

Oxygen, gaseous 3.4

P

P³alkali 1.1; 1.2

Palmitic acid 6.1

Paper pulp 7

Paraffin 5.1

Paraffin oil 5.1

Peanut oil 5.1

Pentane 4

Perchloric acid 6.2; 6.3

Perchloroethylene 4

Petroleum 5.1; 4

Petroleum ether 4

Phenol, aqueous 6.1; 6.2

Phosphoric acid 6.1; 6.2

Phthalic acid 6.1; 6.2

Phthalic anhydride 6.1; 6.2

Pine needle oil 5.1

Potassium acetate, aqueous 7

Potassium bromide, aqueous 7

Potassium carbonate, aqueous 7; 1.1

Potassium chlorate, aqueous 7

Potassium chloride, aqueous 7

Potassium cyanide, aqueous 7

Potassium hydroxide	1.1; 1.2
Potassium hydroxide (= caustic potash)	1.1; 1.2
Potassium nitrate, aqueous	7
Potassium silicate, aqueous	7
Propane	3.2; 4
Propanol	4
Propyl acetate	4
Propylene glycol	4

S

Salicylic acid	6.1; 6.2
Sea water	9.1
Sea water	9.1
Silicone oil	5.2
Silver nitrate, aqueous	7
Soap solution	7
Sodium carbonate	1.1
Sodium chloride	7
Sodium cyanide	7
Sodium hypochlorite	6.1; 6.2
Sodium nitrite	7
Sodium phosphate	7
Sodium silicate	7
Sodium silicate	7
Sodium sulphate	7
Sodium sulphate, aqueous	7
Sodium sulphide	7
Sodium sulphite	7; 6.1
Sodium thiosulphate	7
Steam	2.1-2.3
Steam up to 180 °C	2.1
Steam up to 280 °C	2.2
Steam up to 600 °C	2.3
Stearic acid	6.1
Sulphite alkali	6.1; 6.2
Sulphur dioxide	3.3
Sulphuric acid	6.2; 6.3

T

Tallow	5.1
Tannic acid	6.1; 6.2
Tannin	6.1
Tar	5.1
Tartaric acid	6.1; 6.2
Tetrahydrofuran	4
Toluene	4
Town gas	3.2
Tributyl phosphate	4
Trichloroacetic acid	6.2; 6.3
Trichloroethylene	4
Triethanolamine	8
Turpentine	4

U

Urea, aqueous	7
---------------	---

V

Vinyl acetate	4
Vinyl chloride, aqueous	8

W

Waste water	9.1
Water, boiler feed water	9.1; 9.2
Water, cold	9.1
Water, over 100 °C	9.2
Water, sea water	9.1
Water, up to 100 °C	9.1
Wood pulp	7; 6.1

X

Xylene	4
--------	---

Z

Zinc chloride	6.1; 6.2
Zinc sulphate	6.1

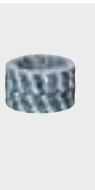

Standardisation Proposals

These recommendations are to be the basis for the rational use of packings.
For further information, please contact our technical help team.

Branch of industry	Medium	Pumps, agitators etc.					Valves				
		Ramilon	Arolan Arochem	Unival Kombilon	Univerdit	Uniflex	Arostat	Unistat	Alchem	Carbosteam G-Spezial	Grafflex
Breweries	Mash	●						●			
	Wort	●						●			
	Water	●						●			
	Beer	●						●			
	Brine	●						●			
	Alkalis	●						●			
	Ammonia	●						●			
	Steam									●	●
Chemical industry in general	Alkalis		●	●		●		●	●		
	Acids, inorganic			●				●	●		
	Acids, organic		●	●		●		●	●		
	Crystalline media				●				●		
	Hardend media				●				●		
	Halogens			●	●	●			●		
	Solvents: aliphatic,	●						●	●		
	Aromatic and chlorinated	●						●	●		
	Alcohols	●	●			●		●	●		
	Esters	●	●			●		●	●		
	Ketones	●	●			●		●	●		
	Oils, greases	●	●			●		●	●		
	Water (ind. waste)	●	●			●		●	●		
Steam									●	●	
Paint industry	Greasing oils	●							●		
	Solvents	●							●		
	Dispersion paints	●							●		
	Synthetic resin paints	●			●				●		
Power plants	Boiler feed water			●		●	●				
	Condensed water	●	●			●	●				
	Cooling water	●	●			●	●				
	River water	●	●			●	●				
	Steam									●	●

Branch of industry	Medium	Pumps, agitators etc.					Valves				
		Ramilon	Arolan Arochem	Unival Kombilon	Univerdit	Uniflex	Arostat	Unistat	Alchem	Carbosteam G-Spezial	Grafflex
Paper industry	Fibrous water	●				●	●				
	Pulps	●				●	●				
	Drum water	●				●	●				
	Condensed water	●				●	●				
	Screening water	●				●	●				
	Waste water	●				●	●				
	Alkalis		●				●				
	Steam									●	●
Refineries	Crude oil		●				●		●		
	Aliphatic hydro-carbons		●			●	●		●		
	Aromatic hydro-carbons		●			●	●		●		
	Chlorinated hydro-carbons		●			●	●		●		
	Bitumen			●		●	●		●		
	Heat transfer oil						●				
	Steam									●	●
	Organic acids			●		●	●		●		
	Inorganic acids			●					●		
	Chlorine			●					●		
Pulp Industry	Boiler liquids: pH 1-3			●		●		●			
	Boiler liquids: pH 13-14			●				●			
	Chlorine dioxide			●		●		●			
	Sulphite water			●		●		●			
	Hypochlorite			●				●			
	Hydrochloric acid			●				●			
	Fibre suspension				●	●		●			
	Steam									●	●
Cement industry	Cement mud	●			●	●	●				
	Water	●					●				
Sugar industry	Water (with sand)	●			●		●				
	Juice	●			●		●				
	Milk of lime	●			●		●				
	Skimmed froth	●			●		●				
	Sugar juice, molasses	●			●		●				
	Steam									●	●

● suitable packing type

Tbl. 2

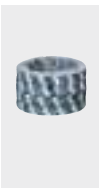

Examples of use

Basic packing arrangements are shown in these application examples.

Basic design of a packing

General application for valves, centrifugal and plunger pumps

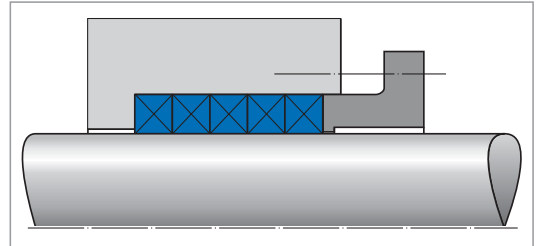

Fig. 1

Packing with lantern ring

- For lubrication
- For the sealing with overpressure
- For sealing with negative pressure (leakage suction)
- For cooling.

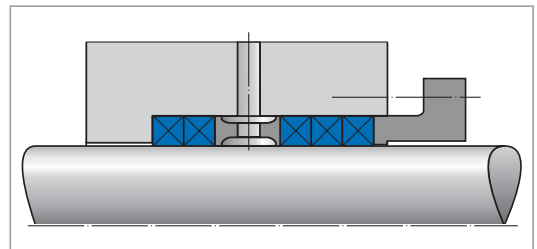

Fig. 2

Gland with different types of packings

- For protection of a plastic packing, braided packings are used as anti-extrusion ring
- Highly pre-compressed rings for bridging large gap widths
- High-density end rings as replacement for metal guides.

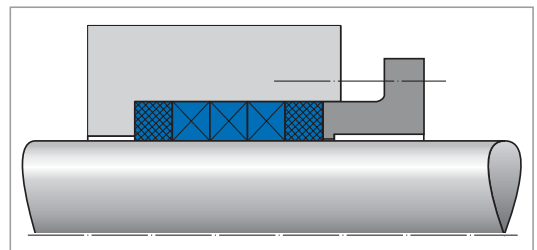
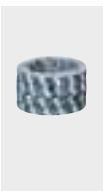

Fig. 3

Packing with two lantern rings

- First ring for high-pressure lubrication, second ring for suction
- Sealing with different media

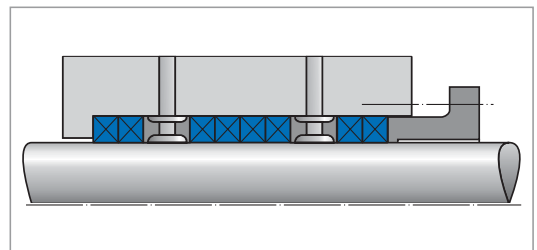

Fig. 4

Packing with outer sleeve cooling

For shaft seals with media with operating temperatures over their boiling point

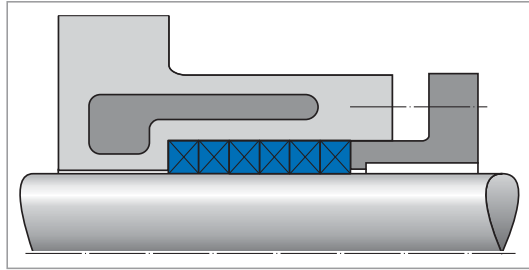

Fig. 5

Packing with spring on inside

Mainly for high pressure plunger pumps
(Spring force only designed for the presealing)

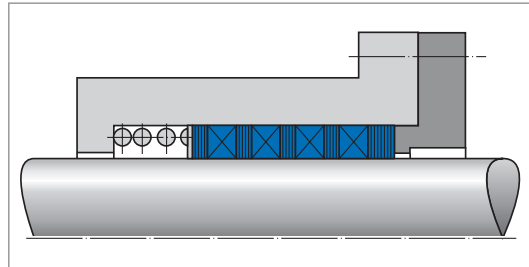

Fig. 6

Packing with springs on outside

For maintenance-free sealing
Spring force must be larger than media pressure times ring area!

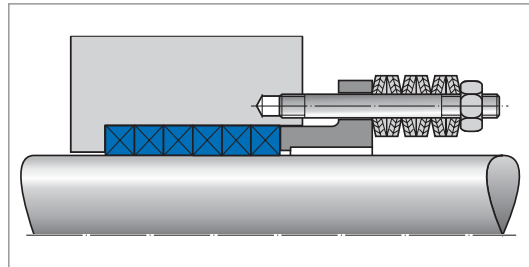

Fig. 7

Self-sealing sealing cover with high density Grafiflex rings

Application e.g. Bredtschneider-Udhe seals

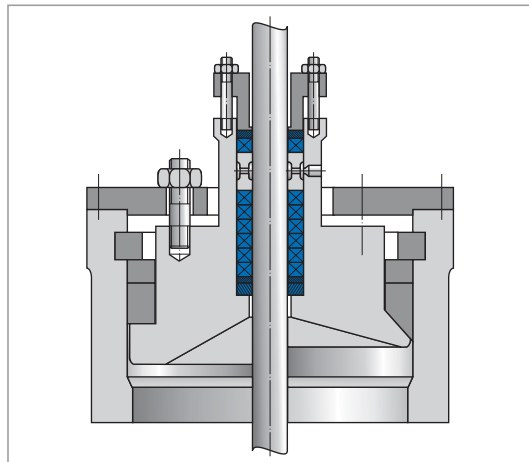
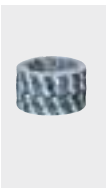

Fig. 8



Fitting Instructions

Either "cut to size" or pre-moulded packing rings are used for glands.

Rings are best cut from by the metre product with the aid of a Merkel packing cutter, cut to exactly the correct length and shaped into a ring on installation around the shaft or spindle.. The packing can also be wound around a shaft or tube with the same diameter and cut to size. A diagonal cut will provide better sealing properties than a butt joint. Adhesive tape is applied to packings without a binding agent on both sides of the cut prior to cutting to prevent fraying. The cut is made through the tape.

The prepared rings are then inserted one after the other in the packing with the cuts offset to one another and tightened using the gland nuts. The packing should be tightened firmly initially so that it can mould to the interior of the gland. The gland nuts are then loosened again and re-tightened with moderate force.

Pre-compression of packing

The correct pre-compression and operating compression is dependent on the type of packing and its application. The appropriate nut forces can only be measured with a torque wrench or similar instrument

Pump packings

An operating compression of 1,05 – 2x times the pressure of the medium is used for pump packings. However, a minimum compression of 0,5 – 1,5 N/mm² is required.

Valve packings

An operating compression of 2 – 5x times the medium pressure and a minimum compression of 5 N/mm² is used for valve packings.

Please consult our technical advisory service for the correct values.

"Running in" new packings

Shaft seals are particularly susceptible to thermal damage during the "running-in" period. Therefore it is important to pay special attention to the shaft temperature during the running-in phase. If the packing runs too hot, the unit must be stopped. After a short cooling down period a homogeneous leakage should appear and the unit can then be restarted. It may be necessary to repeat this procedure several times until the necessary leakage at the shaft is achieved.

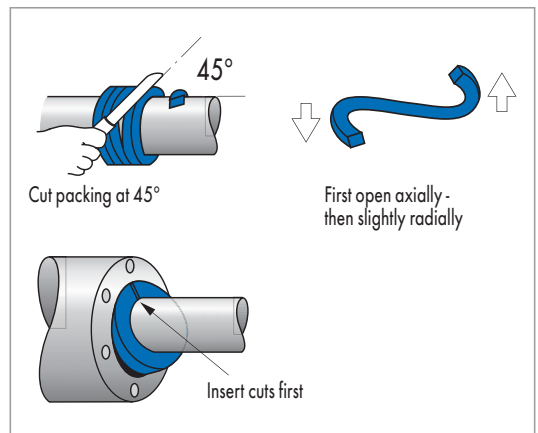

Fig. 9

Installation of moulded rings

Moulded packing rings must be carefully handled during installation so that the sealing properties of these rings are not lost through unnecessary deformation of the cross-section. If the rings cannot be introduced from the front into the packing, they are individually opened a little axially at the ends of the ring so that a gap is produced that can pass over the shaft. Opening in a radial direction should be as small as possible. Install with the cut sections forward (→ Fig. 9).

Tolerances and surfaces

The surface roughness should not exceed the following values:

Rotary pump shafts,

Plungers and spindles $R_a \leq 0,25 \mu\text{m}$,

Housing bores $R_a \leq 2,50 \mu\text{m}$.

These values are valid for general applications.

For high requirements on tightness and service life, the R_a should be reduced to R_a values $\leq 0,1 \mu\text{m}$ for shafts or plungers and spindles.

On rotary pumps the radial shaft deflection must be less than 1/1000 of the shaft diameter. To achieve lower leakage, the runout must not be more than 1/100 of the packing width.

Gap widths

The permissible gap widths between shaft (plunger) and gland bore must be 2/100 of the packing width. If the gap widths are larger or the packing has a tendency to extrude, suitable antiextrusion end rings must be provided.

A copy of our current installation instructions is included with each delivery.

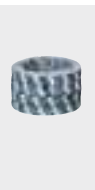

Products

Packings

Pre-Selection Packings	769		
Merkel Acrylon 6130	770	Merkel G-Spezial S 6565	792
Merkel Alchem 6375	771	Merkel Compound Packing HT 7102	793
Merkel Alchem ST 6377	772	Merkel Kombilon 6742	794
Merkel Aquastar Hell 4315	773	Merkel Ramiflex 4510	795
Merkel Arochem 6212	774	Merkel Ramilon 4586	796
Merkel Arochem II 6211	775	Merkel Special Carbon Packing 6540	797
Merkel Arochem S 6216	776	Merkel Cover Lid Seal Type 6324	798
Merkel Aroflex 6226	777	Merkel Thermaflex 6400	799
Merkel Arolan 6210	778	Merkel Unichem 6313	800
Merkel Arolan II 6215	779	Merkel Unichem FDA 6315	801
Merkel Arostat 6204	780	Merkel Uniflex 6588	802
Merkel Carboflex 6587	781	Merkel Unimix 7105	803
Merkel Carbosteam® 6550	782	Merkel Unimix 7106	804
Merkel Carbosteam® S 6555	783	Merkel Unistat 6303	805
Merkel Cerampack 6450	784	Merkel Unival 6323	806
Merkel Cerampack HT 6451	785	Merkel Unival GFO® 6329	807
Merkel Endless Packing Rings	786	Merkel Unival II 6326	808
Merkel Flexalon 6250	787	Merkel Univerdit® 7000	809
Merkel Grafolan 6575	788	Merkel Varilon SG 6224	810
Merkel Grafolan HT 6570	789	Packing Cutter	811
Merkel G-Spezial 6560	790	Packing Extractor	812
Merkel G-Spezial I 6569	791		



Pre-Selection Packings Standard range

Results from current material research, contemporary design technology and modern manufacturing methods with certified quality assurance form the basis of the Merkel range for a clearly structured, complete standard range of packings. Environmental protection, minimisation of work place load and higher reliability are also in the foreground for packings for valves, rotary pumps, high-pressure plunger pumps etc. Improved sealing performance with as far as possible universal use and longer service life are essential aspects.

Note:

The parameters given are maximum values. They relate to the limits for the carrier materials and impregnation. The temperature operating limit can be affected by the related pressure level. The pressure/temperature ratio is, however, also largely dependent on the medium. The simultaneous occurrence of maximum loads may require load reduction measures in some circumstances.

Article No.	Code	Pressure* [bar]			Speed [m/s]		Temperature [°C]	pH value
		Rotary pumps	Plunger pumps	Valves	Rotary pumps	Plunger pumps		
4586	Ramilon	40	1000*		12,5	2	-30 ... +120	5 ... 11
6204	Arostat			200			-50 ... +250	1 ... 13
6211	Arochem II							
6215	Arolan II	25		100	26		-50 ... +280	1 ... 13
6216	Arochem S	25	250*		25	2	-50 ... +280	1 ... 13
6303	Unistat		800*	250		2	-200 ... +280	0 ... 14
6313	Unichem	15			8		-100 ... +250	0 ... 14
6323	Unival	25		250	20		-100 ... +280	0 ... 14
6375	Alchem		500*	250		2	-200 ... +280	0 ... 14
6501	Grafiflex			1000			-200 ... +550 ¹⁾ -200 ... +700 ²⁾ -200 ... +2500 ³⁾	0 ... 14
	Grafiflex Cover Seal			1000			-200 ... +550 ¹⁾ -200 ... +700 ²⁾ -200 ... +2500 ³⁾	0 ... 14
6550	Carbo-steam			300			-30 ... +400 ¹⁾ -30 ... +550 ²⁾	0 ... 14
6560	G-Spezial			450			-200 ... +450 ¹⁾ -200 ... +550 ²⁾	0 ... 14
6565	G-Spezial S			450			-200 ... +450 ¹⁾ -200 ... +550 ²⁾	0 ... 14
6588	Uniflex	25			25		-50 ... +280	1 ... 13
6742	Kombilon	25			20		-100 ... +280	0 ... 14
7000	Univerdit	25*		160*	6		-30 ... +250	0 ... 14

¹⁾ the majority of media and air

²⁾ steam

³⁾ inert gas

* installation with end rings

Ordering note:

Standard packings are supplied by the kilo. The content of the boxes in kg in each case is given in the dimension lists in the kg/box column. Packing can also be supplied as rings; on request.



Merkel Acrylon 6130

Product description

Merkel Acrylon is manufactured from acrylic yarn and impregnated with a special PTFE dispersion. This minimises the friction and increases the cross sectional density.

Merkel Acrylon also contains silicon oil to ensure good sliding qualities.

Product advantages

- Long service life
- High density and low frictional resistance
- Light running properties.

Application

Rotary and plunger pumps.

Operating conditions

Rotary pump

Operating pressure	Temperature	Speed	pH value
20 bar	-50 ... +150 °C	12 m/s	2 ... 12

Plunger pumps

Operating pressure	Temperature	Speed	pH value
100 bar	-50 ... +150 °C	12 m/s	2 ... 12

Media

Cold water, drinking water, salt water, warm water, aqueous solutions containing solid particles, oils, greases, solvents, foodstuffs.

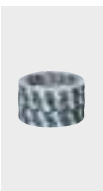

Merkel Alchem 6375

Product description

Merkel Alchem is made from pure PTFE yarns and is additionally impregnated with PTFE. This guarantees excellent chemical resistance. The high cross sectional density and the tight braid structure ensure a very good sealing behaviour. The packing has a good form stability and a low shrinkage behaviour. Alchem is thus also well suited for plunger pumps.

A special type, Merkel Alchem ST, is available for gaseous oxygen, drinking water and for the food processing industry.

Product advantages

- Very low leak rates
- Very low shrinkage behaviour
- No danger of colour contamination.

Application

Plunger pumps, valves.

Operating conditions

Plunger pumps

Operating pressure	Temperature	Speed	pH value
500 bar*	-200 ... +280 °C	2 m/s	0 ... 14

* installation with end rings

Valves

Operating pressure	Temperature	pH value
250 bar	-200 ... +280 °C	0 ... 14

Media

All chemicals including concentrated hot acids and alkalis.
 Exceptions: molten alkali metals, fluorine and some fluorine compounds.



Merkel Alchem ST 6377

Product description

Merkel Alchem ST is manufactured from pure PTFE yarns that guarantee an exceptional chemical resistance. The high density and tight braid structure of the packing ensures a good leakage behaviour. Merkel Alchem ST is suitable for all chemical applications and has approval for the use with gaseous oxygen. The material was analysed by the BAM (Bundesanstalt für Materialprüfung - German Federal Institute for Material Testing) and can be used in valves up to the following parameters without consideration. Maximum temperature up to 60 °C and maximum oxygen pressure up to 25 bar. The material is also suitable for contact with foodstuffs. Testing through FMPA (Forschungs- und Materialprüfanstalt Baden-Württemberg, Stuttgart - Research and Testing Institute Baden-Württemberg, Stuttgart).

Product advantages

- High chemical resistance
- Good leakage behaviour.

Application

Valves.

Operating conditions

Operating pressure	Temperature	pH value
250 bar	-200 ... +280 °C	0 ... 14

Media

All chemicals including concentrated hot acids and alkalis.
 Exceptions: molten alkali metals, fluorine and some fluorine compounds.



Merkel Aquastar Hell 4315

Product description

Made from fine DIAPLEX® cotton thread braided rotary pump packing impregnated with a universally resistant mineral grease.

For all simple rotary applications with drinking water, sea water and lightly acidic and alkaline sewage.

Product advantages

- Cost-effective for simple applications
- Prevents overheating during critical running-in phase
- Protects the shaft.

Application

Rotary pumps.

Operating conditions

Operating pressure	Temperature	Speed	pH value
16 bar	-30 ... +100 °C	6 m/s	6 ... 9

Media

Cold and warm water, air, etc.



Merkel Arochem 6212

Product description

Merkel Arochem is the graphite-free version of our aramide/PTFE combination braid with good gliding PTFE silk on the contact area and high-strength aramide yarn on the edges.

The good sliding properties of the PTFE, the high tensile strength and the extremely low tendency towards gap extrusion of the stabile aramide yarns are the basis for successful use in plunger pumps. Arochem has also established itself for the sealing of mixers, kneaders and soot blowers.

The normal chambering of PTFE silk packings at high pressures and limit temperatures is not applicable. Due to the good chemical resistance of the PTFE silk and the aramide yarns, this yellow/white packing has a wide range of application.

Product advantages

- Stabilised packing with long service life
- Protects the shaft
- No possible discoloration of the medium.

Application

All water pump applications.

Operating conditions

Operating pressure	Temperature	Speed	pH value
500 bar	-50 ... +280 °C	2 m/s	2 ... 13

Media

Cold and hot water, steam, organic solvents and chemical materials, oils, greases, diluted acids and alkalis.



Merkel Arochem II 6211

Product description

Merkel Arochem II combination braid consists of aramide and PTFE graphite compound yarn. The DIAPLEX® braiding makes this packing especially stable. Merkel Arochem II is particularly suitable for the sealing of plungers and low speed shafts. The graphite-filled PTFE yarn on the contact area has very good sliding properties and protects the plunger or shaft surface. The stable braided aramide yarn at the packing edges protects against gap extrusion and ensures a long service life. Merkel Arochem II is thus especially suitable for difficult sealing cases such as bridging large gaps and with abrasive media. In high pressure plunger pumps in end ring installation with pretensioned packing sets especially long service life with constant sealing effect is achieved.

Product advantages

- Low frictional heat
- Protects the shaft
- Resistant to abrasive media particles.

Application

Pumps.

Operating conditions

Operating pressure	Temperature	Speed	pH value
500 bar*	-50 ... +280 °C	2 m/s	1 ... 13

* installation with end rings

Media

Cold and hot water, organic solvents and chemical materials, oils, greases, diluted acids and alkalis.

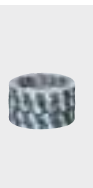

Merkel Arochem S 6216

Product description

Merkel Arochem S combines the advantages of two highly developed yarn materials for the sealing of high-speed shafts.

The special running properties of thermally-resistant PTFE-graphite compound yarns guarantees shaft protection and allows for brief dry running without damage. The wear-resistant aramide yarn edges prevent extrusion and protects against abrasive media. Merkel Arochem S contains a universally stable silicone-free running-in lubricant. This ensures sufficient lubrication during the critical running-in phase.

Product advantages

- Smooth sliding, low friction
- Prevents extrusion, extremely wear-resistant
- Ideally suited for high pressures, no extruding into the sealing gap.

Application

Rotary pump, plunger pumps.

Operating conditions

Rotary pump

Operating pressure	Temperature	Speed	pH value
25 bar	-50 ... +280 °C	25 m/s	1 ... 13

Plunger pumps

Operating pressure	Temperature	Speed	pH value
250 bar*	-50 ... +280 °C	2 m/s	1 ... 13

* installation with end rings

Media

Hot water, salt solutions, alkalis, organic solvents, hydro-carbons, medium concentration acids.



Merkel Aroflex 6226

Product description

Merkel Aroflex is a grease-impregnated pump packing. Light running properties and stability at high temperatures ensure a high performance and long service life.

The impregnation of the tear-resistant aramide-based yarn with a sealed grease/graphite impregnation guarantees a high running property of this packing. The high melting point of the impregnation protects the packing against bleeding and makes Merkel Aroflex a reliable packing at high temperatures.

Product advantages

- Very good sealing against abrasive media
- Good cross sectional density and low friction
- No loss of volume at high temperatures.

Application

Rotary pumps.

Operating conditions

Operating pressure	Temperature	Speed	pH value
16 bar	-10 ... +150 °C	10 m/s	2 ... 13

Media

Cold and hot water, slop, contaminated water with dirt, thread and cloth particles, sugared water, molasses, salt solutions, diluted acids and alkalis.



Merkel Arolan 6210

Product description

Merkel Arolan made from highly wear-resistant aramide yarn has already proven itself in the most diverse applications. Especially where hardening, crystallising or abrasive media can have a damaging effect on the packing, Arolan offers a long-lasting resistance. Proven application areas are refiners, material, juice and mud pumps, but also plunger pumps, paddle dryers and agitators.

A strong adhesion of the PTFE to the smooth yarn is achieved by a special pre-treatment process. PTFE optimises the sliding properties and closes the creep paths in the braid, the adhesion of the yarns to each other is improved.

A physiologically harmless running-in lubricant supports the sealing effect at low gland packing tension.

Product advantages

- Very long service life, even with very abrasive media
- Easy handling
- Easy running properties
- Ideal for application with shaft deflection.

Application

Rotary and plunger pumps.

Operating conditions

Rotary pumps

Operating pressure	Temperature	Speed	pH value
25 bar	-50 ... +280 °C	26 m/s	1 ... 13

Plunger pumps

Operating pressure	Temperature	Speed	pH value
200 bar	-50 ... +280 °C	2 m/s	1 ... 13

Media

Cold and hot water, salt solutions, organic solvents, hydro-carbons, oils, greases, diluted acids and alkalis, steam up to 180 °C.

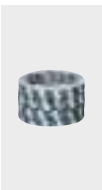

Merkel Arolan II 6215

Product description

Merkel Arolan II consists of highly wear-resistant aramide yarn as well as a special PTFE impregnation and a universally stable running-in lubricant. The high wear resistance paired with a wide thermal and chemical operating range makes Merkel Arolan II a universal packing for many branches of industry.

Product advantages

- For sealing of abrasive media
- Very long service life
- Ideal for application with shaft deflection.

Application

Rotary pumps, valves.

Operating conditions

Rotary pump

Operating pressure	Temperature	Speed	pH value
25 bar	-50 ... +280 °C	26 m/s	1 ... 13

Valves

Operating pressure	Temperature	pH value
100 bar	-50 ... +280 °C	1 ... 13

Media

Cold and hot water, salt solutions, organic solvents, hydro-carbons, oils, greases, diluted acids and alkalis.



Merkel Arostat 6204

Product description

Merkel Arostat is manufactured from a wear-resistant and flexible aramide yarn. The packing has a multi-stage PTFE impregnation.

This results in a very tight and elastic structure which makes Merkel Arostat ideal for static covers and housing seals.

Product advantages

- Resistance even against very abrasive media
- High cross sectional density and low leakage
- Low maintenance.

Application

Valves.

Operating conditions

Operating pressure	Temperature	pH value
200 bar	-50 ... +250 °C	1 ... 13

Media

Cold and hot water, steam up to 180 °C, salt solutions, organic solvents, hydro-carbons, oils, greases, diluted acids and alkalis.

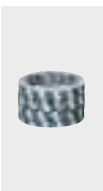

Merkel Carboflex 6587

Product description

Merkel Carboflex behaves with good volume stability and almost universal chemical resistance. The low elongation coefficient, a small friction value and the ability to overcome the critical running-in phase prevents sudden, uncontrolled production of heat at high sliding speeds. The impregnation selected to suit the carbon fibres as well as the specially selected lubricant benefits the running-in process.

Product advantages

- Good chemical resistance
- Good heat dissipation
- Low friction.

Application

Pumps.

Operating conditions

Operating pressure	Temperature	Speed	pH value
25 bar	-60 ... +300 °C	25 m/s	0 ... 14

Media

Acids, alkalis, hydro-carbon, boiler feed water, gases, steam, etc. Exceptions: strongly oxidising salt solutions, concentrated sulphuric acid, nitric acid.

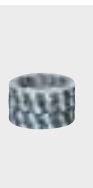

Merkel Carbosteam® 6550

Product description

Merkel Carbosteam is braided from flexible carbon yarns with a special graphite impregnation. Due to its excellent temperature stability, the packing is especially used in high-temperature steam applications.

Due to its high pressure and extrusion resistance, Merkel Carbosteam is ideal as end ring in conjunction with Grafiflex.

Product advantages

- Very high temperature resistance
- Low friction, long service life
- Suitable as extrusion protection and wiper in combination with Merkel Graffiflex and Merkel G-Spezial.

Application

Valves.

Operating conditions

Operating pressure	Temperature	pH value
300 bar	-30 ... +400 °C ¹⁾	0 ... 14
	-30 ... +550 °C ²⁾	

¹⁾ the majority of media and air

²⁾ steam

Media

Hot water, steam, acids and alkalis. Exceptions: strongly oxidising acids such as hot sulphuric and nitric acid.

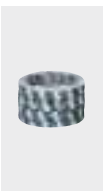

Merkel Carbosteam® S 6555

Product description

Merkel Carbosteam S consists of a flexible graphite core with a wear-resistant carbon yarn jacket. Besides the good elasticity and large cross sectional density, this packing has a continuous volume stability. The jacket is sealed and heat-resistant. The graphite-filled impregnation facilitates fitting and the sliding behaviour on the spindle is optimised.

The content of soluble chloride for this packing is below 50 ppm.

Merkel Carbosteam S is used in particular in power generation and is used in all industries where high temperatures and aggressive media are used.

Product advantages

- High temperature resistant and good heat dissipation
- Low leakage
- Can be used as end ring for extrusion protection and as wiper with Merkel Grafiflex or Merkel G-Spezial.

Application

Valves.

Operating conditions

Operating pressure	Temperature	pH value
300 bar	-30 ... +400 °C ¹⁾	0 ... 14
	-30 ... +550 °C ²⁾	

¹⁾ the majority of media and air

²⁾ steam

Media

Hot water, steam, gases, oils, solvents, acids and alkalis. Exceptions: strongly oxidising acids such as hot sulphuric and nitric acid.

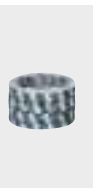

Merkel Cerampack 6450

Product description

Merkel Cerampack is a glass fibre packing with a special graphite impregnation. It is particularly suitable for static sealing in high-temperature applications. The graphite impregnation increases the cross-sectional density and improves the elasticity.

Typical operating conditions are for the sealing of boilers, oven doors, flaps and covers. The packing is also suitable for the thermal isolation of piping.

Product advantages

- Very low leakage values
- Prevents overheating during critical running-in phase
- Excellent sealing behaviour, especially with low-pressure valves.

Application

Valves.

Operating conditions

Operating pressure	Temperature	pH value
10 bar	0 ... +550 °C	5 ... 9

Media

Water, steam, oil, neutral and dry gases.

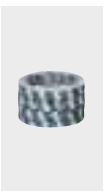

Merkel Cerampack HT 6451

Product description

Merkel Cerampack HT is a glass fibre packing with a cross-sectionally sealed PTFE impregnation. It is particularly suitable for static sealing of covers, doors or housings. The packing is also suitable for valve applications.

Product advantages

- Very high sealing effect
- Good spring back
- Good media resistance.

Application

Valves.

Operating conditions

Operating pressure	Temperature	pH value
100 bar	-50 ... +280 °C	2 ... 12

Media

Water, steam, oil, neutral and dry gases.



Merkel Endless Packing Rings

Product description

Simrit manufactures endless packing rings in a whole variety of materials and dimensions. The sealing rings consist of a concentric hose braid and an optional elastomer core. The elastomer core guarantees a constant sealing force over the entire service life. This is ideal for static cover seals with a high number of open/close cycles. The outer braid provides good wear protection and protects against attacks by chemicals. Endless packing rings can also be used for many applications with minor active movements.

Various yarn, core and impregnation combinations offer the ideal seal for a whole variety of applications.

Product advantages

- Low leakage
- Increased elasticity and spring back
- Good chemical resistance.

Application

Cover and housing seals, tank covers, manholes, filters, dryers, chemical mixer housings, rotary valves, rotary furnaces.

Material

Yarn	Yarn or elastomer core	Impregnation
Ramie, aramide, PTFE, PTFE/ graphite compounds, carbon	NR, EPDM, MVQ	PTFE, graphite

Operating conditions

Operating pressure	Temperature	Speed	pH value
10 bar*	-30 ... +550 °C*	2 m/s*	0 ... 14*

* depending on material combination

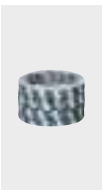

Merkel Flexalon 6250

Product description

Merkel Flexalon is a universal packing for the paper industry. But it is also suitable for the foodstuff industry, chemical and sewage treatment plants. Besides being used for rotary pumps, the packing can also be used in for mixers, kneaders, and refiners.

Merkel Flexalon is manufactured from a white, elastic synthetic yarn based on Meta Aramide. The packing thus offers a good resistance to abrasive media in contrast to PTFE products. But in comparison to Para Aramide packings, Merkel Flexalon protects the shaft significantly more.

The leakage is minimised through a high density and flexible braid structure. The silicone-free running-in lubricant ensures a trouble-free running-in. The white yarn and the impregnation prevents a colour contamination of the medium.

The Fraunhofer Institute for Process Technology and Packaging in Freising has certified the packing for use in food processing machines as per FDA US 21 CFR 170.3 (i) and Article 3 of the EU Regulation 1935/2004.

Product advantages

- Extrusion-resistant but protects the shaft
- Low maintenance
- Low leakage.

Application

Rotary pumps.

Operating conditions

Operating pressure	Temperature	Speed	pH value
25 bar	-50 ... +250 °C	25 m/s	1 ... 13

Media

Cold and hot water, salt solutions, organic solvents, hydro-carbons, oils, greases, diluted acids and alkalis, steam up to 180 °C.



Merkel Grafolan 6575

Product description

Merkel Grafolan consists of graphite yarn which is created through an energy-intensive thermal transformation process. It features high chemical resistance and temperature stability. An added lubricant ensures good running-in behaviour at all speeds. Merkel Grafolan is used in many areas of chemistry – in pumps, agitators and paddle dryers – as well as in feed water pumps for energy production. Compression-moulded rings from Merkel Grafolan 6576 (without additional lubricant) are supplied.

Product advantages

- High temperature resistant
- Also seals for slight shaft deflection
- Good heat dissipation.

Application

Rotary pumps, valves.

Operating conditions

Rotary pumps

Operating pressure	Temperature	Speed	pH value
300 bar	-60 ... +300 °C	25 m/s	0 ... 14

Valves

Operating pressure	Temperature	pH value
320 bar	-60 ... +300 °C	0 ... 14

Media

Acids, alkalis, hydro-carbon, boiler feed water, gases, steam, etc. Exceptions: strongly oxidising salt solutions, concentrated sulphuric acid, nitric acid.

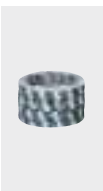

Merkel Grafolan HT 6570

Product description

Merkel Grafolan HT is a valve packing for the highest temperature loads in the area of chemical applications and energy generation. The special high-temperature impregnation ensures the necessary cross-sectional density, benefits the friction behaviour and stabilises the DIAPLEX® braid lattice.

Product advantages

- High temperature resistant
- Low leakage and low friction
- Bridges even large gaps.

Application

Valves.

Operating conditions

Operating pressure	Temperature	pH value
300 bar	-30 ... +450 °C ¹⁾	0 ... 14
	-30 ... +600 °C ²⁾	
	-30 ... +2000 °C ³⁾	

¹⁾ the majority of media and air

²⁾ steam

³⁾ inert gas

Media

Hot water, steam, hot air, acids and alkalis. Exceptions: strongly oxidising acids such as sulphuric and nitric acid.

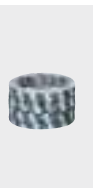

Merkel G-Spezial 6560

Product description

Merkel G-Spezial S is made of temperature resistant, flexible braided graphite yarns each of which is reinforced with a very thin Inconel wire. This highly pressure-resistant braided packing has the same excellent sealing effect as pure graphite rings wound from strip material. Merkel G-Spezial is especially suitable for fast repair service applications. For gaps greater than 0,2 mm, the use of Merkel Carbosteam 6550 is recommended as extrusion protection.

Also available as Merkel G-Spezial I 6569 with corrosion inhibitor.

Product advantages

- High temperature and chemical resistance
- Very low leakage
- High pressure resistance
- Fast repair for a whole variety of valve dimensions.

Application

Valves.

Operating conditions

Operating pressure	Temperature	pH value
450 bar	-200 ... +450 °C ¹⁾	0 ... 14
	-200 ... +550 °C ²⁾	

¹⁾ the majority of media and air

²⁾ steam

Media

Hot water, steam, gases, oils, acids and alkalis. Exceptions: strongly oxidising acids such as sulphuric and nitric acid in high concentrations.

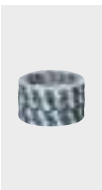

Merkel G-Spezial I 6569

Product description

Merkel G-Spezial I is made of temperature resistant, flexible braided graphite yarns each of which is reinforced with a very thin Inconel wire. The packing is additionally treated with a corrosion inhibitor. This highly pressure-resistant braided packing has the same excellent sealing effect as pure graphite rings wound from strip material and has the added advantage for variable use in the area of repair and service.

Merkel G-Spezial I has a fire test approval according to API 589 Rev. 2.

For gaps greater than 0,2 mm, the use of Merkel Carbo-steam 6550 as extrusion protection is recommended.

Operating conditions

Operating pressure	Temperature	pH value
450 bar	-200 ... +450 °C ¹⁾	1 ... 14
	-200 ... +550 °C ²⁾	

¹⁾ the majority of media and air

²⁾ steam

Media

Hot water, steam, gases, oils, acids and alkalis. Exceptions: strongly oxidising acids such as sulphuric and nitric acid in high concentrations.

Product advantages

- High temperature and chemical resistance
- Very low leakage
- High pressure resistance
- Fast repair for a whole variety of valve dimensions.

Application

Universal repair packing for all valve applications.



Merkel G-Spezial S 6565

Product description

Merkel G-Spezial S is braided from pure, expanded graphite yarns and can be used in pumps and valves. The packing combines all the advantages of the expanded graphite such as high temperature stability and high cross-sectional density. The rings made from Merkel G-Spezial S can simply be cut from the roll for application cases where fast repair is required.

Can be used in combination with end rings from Merkel Carbosteam 6550 for high-pressure valve applications.

Product advantages

- Very high temperature and chemical resistance
- Excellent sealing effect and constant elasticity
- Fast repair for a whole variety of valve dimensions.

Application

Valves, rotary pumps.

Operating conditions

Valves

Operating pressure	Temperature	pH value
250 bar	-200 ... +450 °C ¹⁾	0 ... 14
	-200 ... +550 °C ²⁾	

Rotary pumps

Operating pressure	Temperature	Speed	pH value
250 bar	-200 ... +450 °C ¹⁾	25 m/s	0 ... 14
	-200 ... +550 °C ²⁾		

¹⁾ the majority of media and air

²⁾ steam

Media

Hot water, steam, gases, oils, acids and alkalis. Exceptions: strongly oxidising acids such as sulphuric and nitric acid in high concentrations.



Merkel Compound Packing HT 7102

Product description

Merkel Compound Packing made from thread-stabilised graphite compound for the sealing of butterfly valve stems in exhaust gas valves.

The packing consists of natural graphite and binders that are attached to the graphite threads in a special process. Through this design, a good packable sealing compound is created for the new packing and for the repair operation.

Product advantages

- High temperature resistance
- Good thermal conductivity
- Can compensate slight shaft defects.

Application

Exhaust gas valves.

Operating conditions

Operating pressure	Temperature	pH value
100 bar*	-30 ... +450 °C	0 ... 14

* installation with end rings

Media

Exhaust.

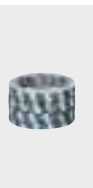

Merkel Kombilon 6742

Product description

Merkel Kombilon consists of an elastic combination braid made from carbon and PTFE yarns. The packing is impregnated with a special PTFE compound and running-in lubricant. The specific composition of Merkel Kombilon ensures very low frictional forces and a high elasticity. This makes the packing especially suitable for mixers and agitators.

The packing maintains its elasticity even after prolonged operation and under high contact pressure. The specially processed carbon yarn is very flexible and protects the shaft particularly well.

Product advantages

- Low leakage rates even with slight shaft deflection
- Long service life
- Excellent performance even at high temperatures.

Application

Rotary pumps, valves.

Operating conditions

Rotary pumps

Operating pressure	Temperature	Speed	pH value
25 bar	-100 ... +280 °C	20 m/s	0 ... 14

Valves

Operating pressure	Temperature	pH value
160 bar	-100 ... +280 °C	0 ... 14

Media

Alkalis, all forms of solvents, alcohols, ketones, esters, oils, acids, hot water, boiler lye, brine, ammonia.

Exceptions: strongly oxidising acids.

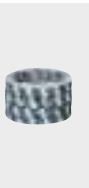

Merkel Ramiflex 4510

Product description

Merkel Ramiflex is a braided pump packing made from a very stable, flexible and tear-resistant ramie yarn DIAPLEX® and impregnated with a bright red special grease. Ramie is many times more tear-resistant than cotton and rot-resistant.

The packing has very good running properties and is extremely wear-resistant in abrasive media such as mud, crystallised suspensions and sewage.

Ramiflex is thus particularly suitable for application in shipping (stern tube and bilge pump sealing).

Product advantages

- Very wear-resistant
- Long service life and better sealing behaviour
- Protects the shaft.

Application

Rotary and plunger pumps.

Operating conditions

Rotary pumps

Operating pressure	Temperature	Speed	pH value
16 bar	0 ... +120 °C	10 m/s	6 ... 9

Plunger pumps

Operating pressure	Temperature	Speed	pH value
100 bar	0 ... +120 °C	1 m/s	6 ... 9

Media

Cold and warm water, air, etc.



Merkel Ramilon 4586

Product description

Merkel Ramilon is braided from ramie yarn, an extremely tear-resistant and water-resistant natural fibre yarn. The packing contain a high degree of PTFE due to a multi-impregnation process.

This guarantees a high cross sectional density and low frictional values. Merkel Ramilon is also used in plunger pumps for high pressure water applications.

The packing materials are FDA approved for use in the food processing industry.

Product advantages

- Long service life
- Does not swell or rot
- Excellent pressure-resistance.

Application

Rotary pumps, refiners, mills, plunger pumps, stern tube applications.

Operating conditions

Rotary pumps

Operating pressure	Temperature	Speed	pH value
40 bar	-40 ... +120 °C	12,5 m/s	5 ... 11

Plunger pumps

Operating pressure	Temperature	Speed	pH value
1000 bar*	-40 ... +120 °C	2 m/s*	5 ... 11

* installation with end rings

Media

Cold water, drinking water, salt water, warm water, aqueous solutions containing solid particles, oils, greases, solvents, foodstuffs.

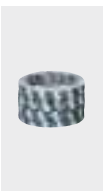

Merkel Special Carbon Packing 6540

Product description

The base material for these special packings is carbon yarns that are combined with lead braiding and impregnated with a graphite-containing mineral grease. The packing protects the shaft and is used wherever ridged shafts endanger the packing material. The interlaced lead braiding provides a smoothing of the shaft surface.

The special carbon yarn packing has already proven itself for years in power plant use for the sealing of air and gas preheaters. In this application, the packing primarily serves to shield the shaft bearings from dust and flue ash. The packing is, however, also suitable for the sealing of acid and alkali pumps.

Product advantages

- Also suitable for shafts with ridges
- Protects the shaft and has good heat dissipation
- Seals dust and flue ash in particular.

Application

Sealing of air and gas preheaters.

Operating conditions

Operating pressure	Temperature	Speed	pH value
16 bar	-50 ... +160 °C	20 m/s	0 ... 14

Media

Cold and hot water, steam, gases, oils, solvents, acids and alkalis. Exceptions: concentrated sulphuric and nitric acids.

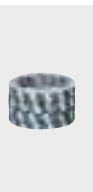

Merkel Cover Lid Seal Type 6324

Product description

The Merkel Cover Lid Seal Type 6324 consists of a concentric hose braid and an optional elastomer core.

The elastomer core guarantees a constant sealing force over the entire service life. This is ideal for static cover seals with a high number of open/close cycles. The outer braid provides good wear protection and protects against attacks by chemicals.

Product advantages

- Low leakage
- Increased elasticity and spring back
- Good chemical resistance.

Application

Cover and housing seals, tank covers, manholes, filters, dryers, chemical mixer housings, rotary valves, rotary furnaces.

Material

Yarn	Elastomer core	Impregnation
PTFE	EPDM, MVQ	PTFE

Operating conditions

Operating pressure	Temperature	Speed	pH value
10 bar	-30 ... +250 °C	2 m/s*	0 ... 14

* depending on material combination

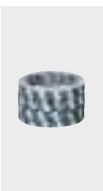

Merkel Thermaflex 6400

Product description

Merkel Thermaflex 6400 is especially suited for static sealing at very high temperatures.

The packing has outstanding thermal isolation properties, good electrical isolation ability and a high resistance to radiation.

Product advantages

- Ideal for high-temperature sealing.

Application

Static high-temperature applications.

Operating conditions

Operating pressure	Temperature	pH value
10 bar	0 ... +1100 °C	2 ... 12

Media

Nitrous gases, inert gases, exhaust gases, acids, diluted alkalis. Exceptions: steam, fluorine, hydrofluoric acid.



Merkel Unichem 6313

Product description

Merkel Unichem is braided from pure PTFE yarns and impregnated with a running-in lubricant. The packing has a very dense structure and is yet soft and flexible. Sealing can be achieved with a minimum amount of gland pressure. Merkel Unichem features very good friction behaviour.

Merkel Unichem is available as a flat strip for static sealing*.

* dimensions on enquiry

Product advantages

- Excellent sealing behaviour with minimum gland pressures
- Very low leak rate
- Suitable for all chemical applications.

Application

Rotary pumps.

Operating conditions

Operating pressure	Temperature	Speed	pH value
15 bar	-100 ... +250 °C	8 m/s	0 ... 14

Media

All chemicals including concentrated hot acids and alkalis. Exceptions: molten alkali metals, fluorine and some fluorine compounds.

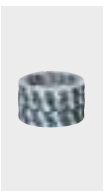

Merkel Unichem FDA 6315

Product description

Merkel Unichem FDA is braided from pure, extruded PTFE yarns with a special filler and silicone oil. The packing has a very dense structure and is yet soft and flexible. The packing has excellent oil absorption properties and can thus be used universally for pumps, valves or static seals.

Merkel Unichem FDA fulfils the FDA regulations and is thus especially suited for the foodstuffs and pharmaceuticals industries.

Product advantages

- Flexible and protects the shaft
- To be used universally
- FDA-compliant.

Application

Pumps and valves in the chemicals and foodstuffs industry.

Operating conditions

Pumps

Operating pressure	Temperature	Speed	pH value
25 bar	-100 ... +280 °C	15 m/s	0 ... 14

Valves

Operating pressure	Temperature	pH value
100 bar	-100 ... +280 °C	0 ... 14

Media

All chemicals including concentrated hot acids and alkalis. Exceptions: molten alkali metals, fluorine and some fluorine compounds.



Merkel Uniflex 6588

Product description

Merkel Uniflex is manufactured from a special flexible yarn with a high carbon content, and a PTFE-graphite impregnation as well as a running-in lubricant.

The packing is very flexible and extrusion-resistant. The impregnation maintains an excellent bond to the braid over the complete life of the packing. The good temperature and volume stability of the packing provides superior sealing behaviour even with minimal gland pressures. Thus, Merkel Uniflex can sometimes also be used for dry running.

Product advantages

- Suitable for dry running
- Superior sealing performance
- Flexible and wear-resistant.

Application

Rotary pumps.

Operating conditions

Operating pressure	Temperature	Speed	pH value
25 bar	-50 ... +280 °C	25 m/s	1 ... 13

Media

Cold and hot water, steam, aqueous solutions, diluted acids and alkalis.

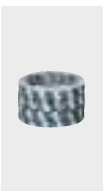

Merkel Unimix 7105

Product description

Merkel Unimix 7105 is a newly developed, injectable fibre compound consisting of PTFE fibres and particles as well as a high-performance lubricant.

With end rings made from Merkel Arolan 6215 or Merkel Unichem 6313, this packing is ideal for use against abrasive media and also for run-in shafts.

Due to the injectability, it is also possible to refill the packing mass during pump operation and thus avoid down-times.

Compared to other compounds, Merkel Unimix 7105 is resistant over the entire pH range from 0 to 14 and due to the shorter fibre lengths, more homogenous and simple to inject.

When delivered, the density of the compound is approx. 1,5 g/cm³ (1 kg ≈ 0,65 l).

Product advantages

- Good chemical resistance
- Low leakage
- No down-times.

Application

Abrasive media in pumps and mixer applications.

Operating conditions

Pumps

Operating pressure	Temperature	Speed	pH value
25 bar	-100 ... +250 °C	10 m/s	0 ... 14

Valves

Operating pressure	Temperature	Speed	pH value
75 bar	-100 ... +250 °C	10 m/s	0 ... 14

Media

Cold and hot water, solutions containing particles, oils, greases, solvents.

Fitting & installation

For optimal installation, we recommend the Merkel Injection Pump 7515. Please request it from us.

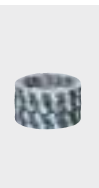

Merkel Unimix 7106

Product description

Merkel Unimix 7106 is a newly developed, injectable fibre compound consisting of PTFE fibres and particles as well as a high-performance lubricant.

With end rings made from Merkel Arolan 6215 or Merkel Unichem 6313, this packing is ideal for use against abrasive media and also for run-in shafts.

Due to the injectability, it is also possible to refill the packing mass during pump operation and thus avoid down-times.

Compared to other compounds, Merkel Unimix 7106 is resistant over the entire pH range from 0 to 14 and due to the shorter fibre lengths, more homogenous and simple to inject.

When delivered, the density of the compound is approx. 1,4 g/cm³ (1 kg ≈ 0,7 l).

Product advantages

- Good chemical resistance
- Low leakage
- No down-times.

Application

Abrasive media in pumps and mixer applications.

Operating conditions

Pumps

Operating pressure	Temperature	Speed	pH value
25 bar	-100 ... +250 °C	10 m/s	0 ... 14

Valves

Operating pressure	Temperature	Speed	pH value
75 bar	-100 ... +250 °C	10 m/s	0 ... 14

Media

Cold and hot water, solutions containing particles, oils, greases, solvents.

Fitting & installation

For optimal installation, we recommend the Merkel injection pump 7515. Please request it from us.

Merkel Unistat 6303

Product description

Merkel Unistat 6303 is braided from a graphite-filled PTFE yarn. The high graphite content ensures good heat dissipation and the PTFE material ensures excellent friction behaviour. The dense and pressure-resistant structure makes the packing especially suitable for plunger pump applications. Due to its chemical resistance, Merkel Unistat 6303 is universally suitable for applications in the chemicals industry.

The packing material is approved for use in the food processing industry.

Product advantages

- High chemical and pressure resistance
- Excellent heat dissipation
- Low leakage.

Application

Plunger pumps, valves.

Operating conditions

Plunger pumps

Operating pressure	Temperature	Speed	pH value
800 bar*	-200 ... +280 °C	2 m/s	0 ... 14

Valves

Operating pressure	Temperature	pH value
250 bar	-200 ... +280 °C	0 ... 14

* installation with end rings

Media

Steam, condensation, alkalis, solvents, almost all acids. Exceptions: highly concentrated nitric acid, oleum. Suitable for use with gaseous oxygen (65 bar to 40 °C/50 bar to 200 °C). Tested by the BAM (Federal Institute for Research and Material Testing).



Merkel Unival 6323

Product description

Merkel Unival 6323 consists of graphite-filled, oiled PTFE yarn. Due to a special braid structure the advantages that this material offers (low thermal expansion and excellent heat conduction) are optimally exploited. Merkel Unival 6323 is a very flexible packing and seals reliably with a minimum of gland pressure, even against thin liquid media that have a tendency to creep. It can also withstand dry friction up to a certain limit. The materials used are approved for use in food processing industry (MPA).

Product advantages

- Ability to run at high speeds
- Longer service life
- Low leakage with a minimum of gland pressure.

Application

Rotary pumps, valves.

Operating conditions

Rotary pump

Operating pressure	Temperature	Speed	pH value
25 bar	-100 ... +280 °C	20 m/s	0 ... 14

Valves

Operating pressure	Temperature	pH value
250 bar*	-100 ... +280 °C	0 ... 14

* installation with end rings

Media

Alkalis, solvents, bitumen, almost all acids. Exceptions: highly concentrated nitric acid, oleum.

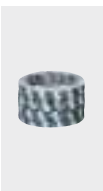

Merkel Unival GFO® 6329

Product description

Due to a special braid structure of Merkel Unival GFO® 6329, the advantages that this material offers (low thermal expansion and excellent heat conduction) are optimally exploited.

The very flexible packing seals reliably with a minimum of gland pressure, even against thin liquid media that have a tendency to creep. Merkel Unival GFO® can also withstand dry friction up to a certain limit.

The packing material is approved for use in the food processing industry (FMFA, Stuttgart).

Product advantages

- Low maintenance
- Long service life, even at higher speeds
- Very low leakage without too strong a tightening of the packing.

Application

Rotary pumps, valves.

Operating conditions

Rotary pump

Operating pressure	Temperature	Speed	pH value
25 bar	-100 ... +280 °C	25 m/s	0 ... 14

Valves

Operating pressure	Temperature	pH value
250 bar	-100 ... +280 °C	0 ... 14

Media

Alkalis, solvents, bitumen, almost all acids. Exceptions: highly concentrated nitric acid, oleum.



Merkel Unival II 6326

Product description

Merkel Unival II consists of graphite-impregnated PTFE yarn. Due to its special braid structure, the advantages that this material offers (low thermal expansion and excellent heat conduction) are optimally exploited.

Merkel Unival II is a very flexible packing and seals reliably with a minimum of gland pressure, even against thin liquid media that have a tendency to creep. It can also withstand dry friction up to a certain limit. Merkel Unival II combines all the advantages of a low priced packing, that withstands all chemically and dynamically demanding conditions in pumps, mixers, kneaders, agitators and dryers.

Product advantages

- Low maintenance
- Long service life, even at higher speeds
- Cost-effective and universally applicable.

Application

Rotary pumps, valves.

Operating conditions

Rotary pump

Operating pressure	Temperature	Speed	pH value
25 bar	-100 ... +280 °C	15 m/s	0 ... 14

Valves

Operating pressure	Temperature	pH value
250 bar	-100 ... +280 °C	0 ... 14

Media

Alkalis, solvents, bitumen, almost all acids. Exceptions: highly concentrated nitric acid, oleum.

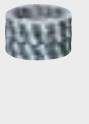

Merkel Univerdit® 7000

Product description

The packing material is approved for use in the food processing industry. Compact extruded packing made of PTFE graphite compound. Merkel Univerdit has extremely good resistance to gas permeation and has the ability to embed abrasive particles. Univerdit remains self-lubricating even during extended periods of operation and therefore reduces friction on shafts and spindles. Generally, Univerdit must always be installed with end rings*.

* End-ring selection is dependent on application parameters.

Product advantages

- Resistance to gas permeation
- Easy installation and long service life
- Ideal for sealing abrasive media
- Can run "dry" in some applications.

Application

Rotary pumps, valves.

Operating conditions

Rotary pump

Operating pressure	Temperature	Speed	pH value
25 bar*	-30 ... +250 °C	6 m/s	0 ... 14

Valves

Operating pressure	Temperature	pH value
160 bar*	-30 ... +250 °C	0 ... 14

* installation with end rings

Media

Alkalis, all forms of solvents, alcohols, ketones, esters, oils, acids, hot water, boiler lye, brine, ammonia.
Exceptions: strongly oxidising acids.

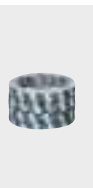

Merkel Varilon SG 6224

Product description

Varilon SG consists of a DIAPLEX® combination braid made from PTFE graphite compound and aramide yarns. The packing is additionally impregnated with PTFE and provided with a running-in lubricant.

Varilon SG is particularly suited for the sealing of fast-running shafts. The high PTFE graphite content provides the packing with very good running properties and a high heat dissipation ability. The aramide yarn gives the packing a high rigidity.

The special design allows the packing to predominantly run on the PTFE graphite compound yarn after shaft-side installation. This protects the shaft and ensures a longer service life.

Product advantages

- Also suitable for media with abrasive particles
- Good running behaviour, low friction power
- Prevents overheating during critical running-in phase.

Application

Plunger and rotary pumps.

Operating conditions

Operating pressure	Temperature	Speed	pH value
25 bar	-50 ... +280 °C	20 m/s	1 ... 13

Media

Hot water, alkalis, organic solvents, salt solutions, hydro-carbons, oils, greases, medium concentration acids.

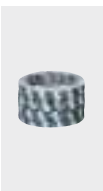

Packing Cutter

Product description

The universal packing cutter was designed for the practical cutting of packings from the roll. With the help of this cutter, packings can be cut accurately and correctly to suit the application. The measuring scale is in inches and millimetres. The scale corresponds to the shaft or spindle diameter. The packing cross-section is taken into account by adjusting the slide. The slide stop and cutting guide are designed for the optimal cut at 45°.

Product advantages

- Robust plastic with lateral fastening lugs
- For radial inclined cuts of 45° in the shaft and spindle range of Ø 5 to 120 mm and 2 to 20 mm packing cross-section
- Special design for shaft/spindle area; Ø to 320 mm
- A clamping device for holding the packing to the cutting guide
- Cross-section scale on a lockable aluminium slide with packing stop
- Finger guard
- Practical quality knife as an accessory (can be ordered as replacement knife 7513).

Packing Cutter	Article No.
Ø ... 120 mm	7505-24-118583
Ø ... 320 mm	7505-24-142428
Replacement knife	7513-24-122885

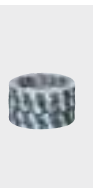

Packing Extractor

Product description

A clean housing is important for the sealing properties of a new packing. For this reason used seals must be carefully and completely removed from the sealing box. Packing extractors were developed for the rapid and careful removal of packings. The forged, helical-shaped tips are firmly joined to the extractor shaft. With their large pitch, they can easily be screwed into all types of braided and fabric packings. With the flexible and powerful shaft, even difficult to access packing gland boxes are easy to reach. The T-bar handle is designed

for the tensile load and sits easily in the hand. Packing extractors sets are supplied in a practical case. Each set contains each size of steel extractor: 22 cm, 33 cm, 44 cm long for packing boxes from 6 mm, 10 mm and 13 mm width. For the installation of packings, metal ring segments can be screwed onto the extractors and in this way they become the ideal tool for pushing the packing rings evenly into the housing without damage.

Fitting & installation

Metal ring segment pressure pieces with tube-shaped shoulder and internal thread, to attach to size 0 to 3 packing extractors.

Ring segments	
Size	Article No.
3	7511 - 24 - 107988
2	7511 - 24 - 107989
1	7511 - 24 - 107990
0	7511 - 24 - 107991

